

# WELKER JET<sup>®</sup> CONTROL VALVES

Top Entry, Flanged and Insert Styles

HIGH RECOVERY

QUICK RESPONSE

EASY MAINTENANCE

PRESSURE OR FLOW CONTROL



MINIMUM NOISE

POSITIVE SHUT-OFF

INFINITE RANGEABILITY

HIGH CAPACITY



## 3 CONFIGURATIONS TO FIT YOUR APPLICATIONS

In 1958, R.H. Welker designed the first rubber plug type control valve to meet the demands of the gas industry for a quiet, versatile control valve. The many refinements and improvements made since that time have been incorporated into the current line of **WELKER JET®** Control Valves.

The basic design consists of a rubber plug which is expanded by a hydraulically operated piston and cylinder system. As the hydraulic force on the plug increases, it expands radially until it seals against the inside of a fixed liner. Hydraulic pressure is provided by a pneumatically operated diaphragm motor.



*This streamlined, aerodynamic design generates a unique flowpath that is unmatched by any other control valve on the market today.*

### Advantages of this design include:

**MINIMUM NOISE** — The flow path through the **WELKER JET®** Control Valve is a streamlined, high recovery design (see graph). Turbulence is greatly reduced, allowing a noise reduction of 10 to 30 dbA over other types of control valves.

**QUICK RESPONSE** — The hydraulic linkage between the diaphragm motor and control valve allows instant response to instrument pressure changes. The virtually frictionless hydraulic system eliminates the need for a positioner.

**POSITIVE SHUT-OFF** — The large, flexible sealing area will achieve a positive bubble tight shut-off, even around weld slag and other large particles.

**INFINITE RANGEABILITY** — Precise regulation is possible over 100% of the control valve's range, from full flow down to no flow. The 8-inch **WELKER JET®** Control Valve is as accurate at low flow conditions as the 1-inch model. This control valve cannot be oversized.

**SIMPLIFIED MAINTENANCE** — The Top Entry **WELKER JET®** Control Valve is designed so that routine maintenance can be performed without opening the hydraulic system or removing the body from the line.

**WELKER JET®** Control Valves are available either as Flanged, Insert, or Top Entry Styles. Applications include flow control and pressure control. **WELKER JET®** Control Valves may also be used in monitor regulator applications.

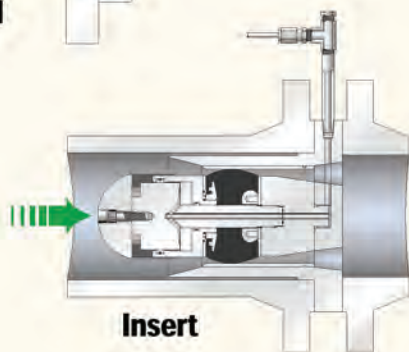
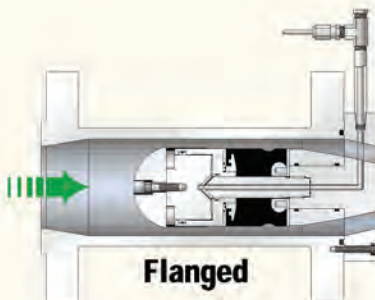
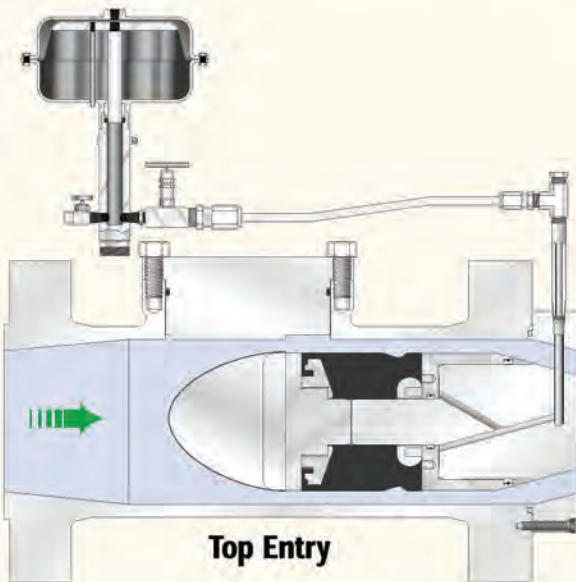

# TOP ENTRY CONTROL VALVE & COMPONENTS

**HIGH RECOVERY**



**RANGEABILITY**

**MINIMUM NOISE**



**SIMPLE DESIGN**



# TYPICAL INSTALLATIONS

**INSTRUMENTATION** for flow control with pressure override consists of the standard instruments with a flow controller, orifice plate and high selector relay. A more sophisticated dehydration assembly is also used.

*Install with appropriate downstream safety device in accordance with all applicable regulations.*

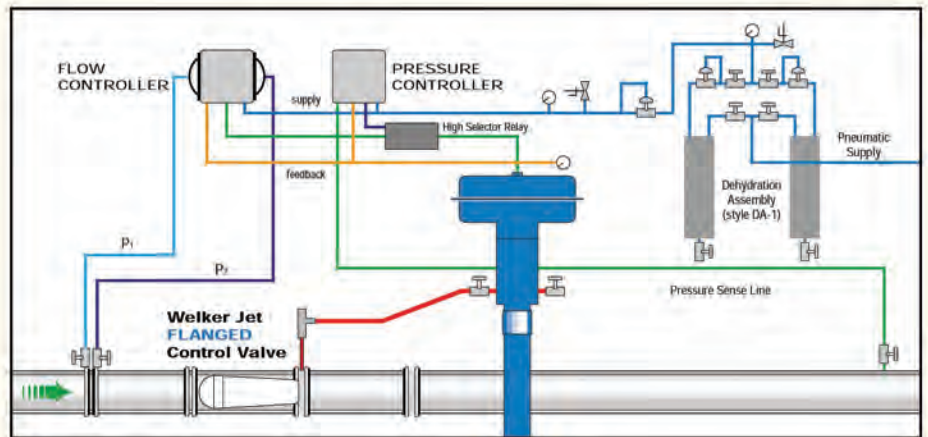

**STANDARD INSTRUMENTATION** consists of a filter dryer, first and second stage regulation with appropriate relief valve, and a pneumatic controller. The pressure sense line should be mounted as far downstream as possible.

(Inset) An **amplifying relay** is used when the pressure requirements for positive shut off exceed the controller output or when greater response time is required. The amplifying relay is mounted between the controller output and the diaphragm motor.

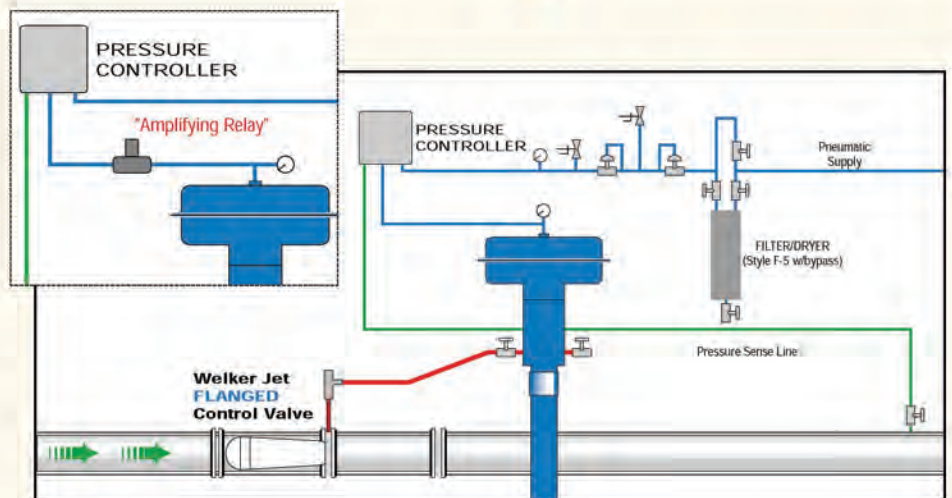

A **PILOT OPERATOR** is used for pressure control. Sensor line should be mounted as far downstream as possible. Filtered and regulated supply should be used to operate pilot.

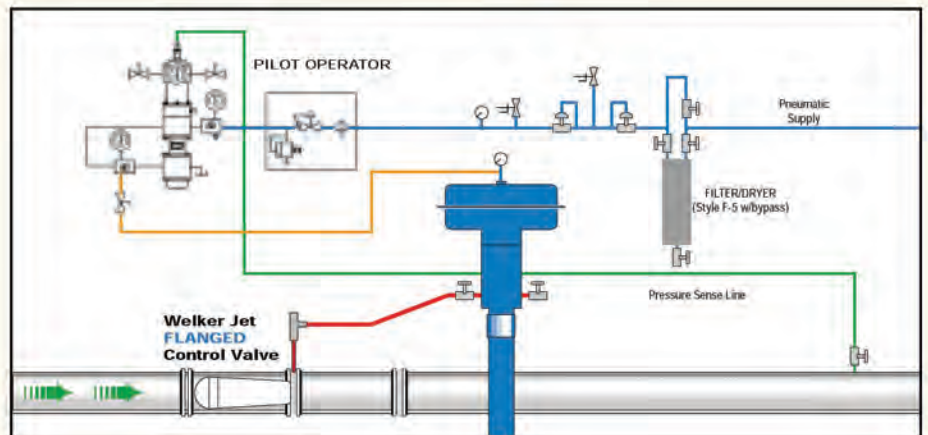

**I/P OPERATION** is used for flow or pressure control. A 4-20mA or 1-5V signal from the flow computer operates the control valve.

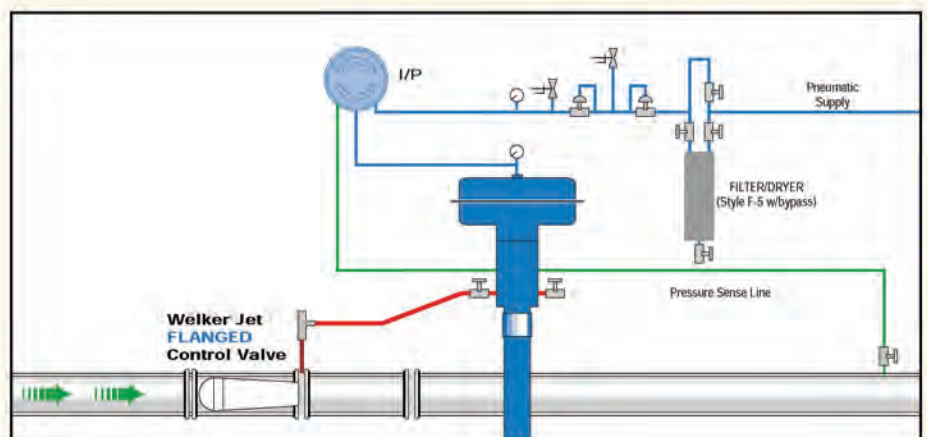

# APPLICATIONS

**HIGH RECOVERY** is a term which refers to a design characteristic of a control valve. It relates directly to the kinetic energy present in a flowing stream of gas. A high recovery design is one which wastes little kinetic energy. High recovery, therefore, means high energy recovery.

In a conventional control valve, the flowing stream is forced through a path requiring abrupt changes in direction. These changes cause the flowing stream to impinge directly on the walls of the valve in some areas while causing vortex turbulence to form in others. The result is energy robbing noise and vibration. Energy lost to noise and vibration cannot be recovered.

By providing a straight, smooth flow path, the **WELKER JET®** Control Valve operates with greatly reduced turbulence. Less energy is lost to noise and vibration. The result is a quiet control valve with high recovery characteristics.

The advantages of the high recovery characteristics are illustrated by comparing the **WELKER JET®** Control Valve capacity with a conventional control valve capacity.

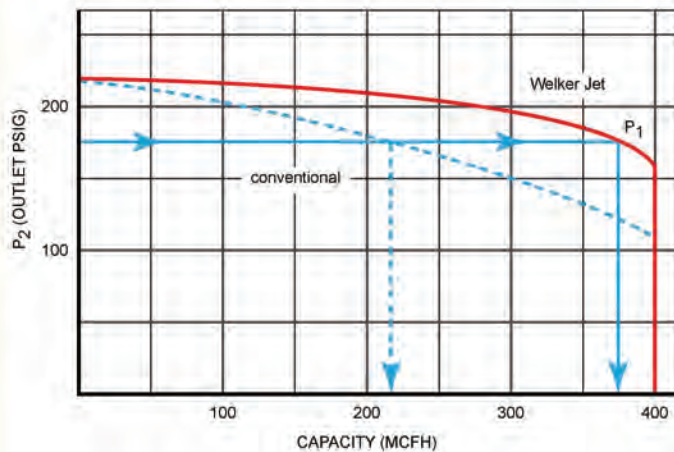

As shown in the graph above, maximum capacity for both valves is equal when the pressure drop is high. As the outlet pressure increases, the **WELKER JET®** Control Valve continues to provide maximum capacity long after the capacity of the conventional valve begins to decrease. It also compares a conventional valve and a **WELKER JET®** with identical capacities when cutting from 220 psig to 110 psig. However, under conditions with an inlet pressure of 220 psig and an outlet pressure of 175 psig, the **WELKER JET®** capacity will be 74% greater than the conventional capacity.

The **TOP ENTRY** valve is designed to be mounted in the line as part of the piping. The inspection spool allows the control valve to be removed easily for inspection.

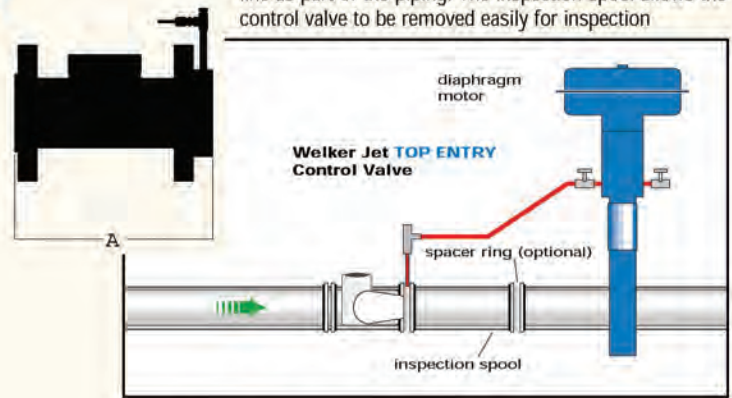

The **INSERT** style valve is designed to be installed between two flanges of a piping system. The inspection spool is recommended to allow removal of the control valve for routine inspection.

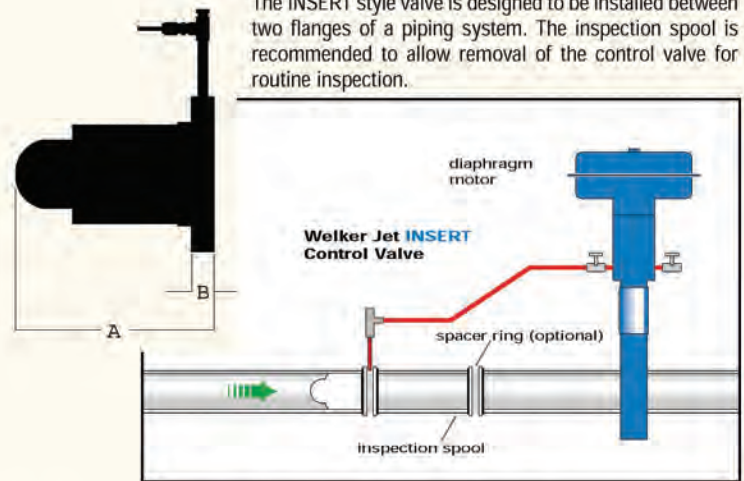

The **FLANGED** valve is designed to be mounted in the line as part of the piping. The inspection spool allows the control valve to be removed easily for inspection.

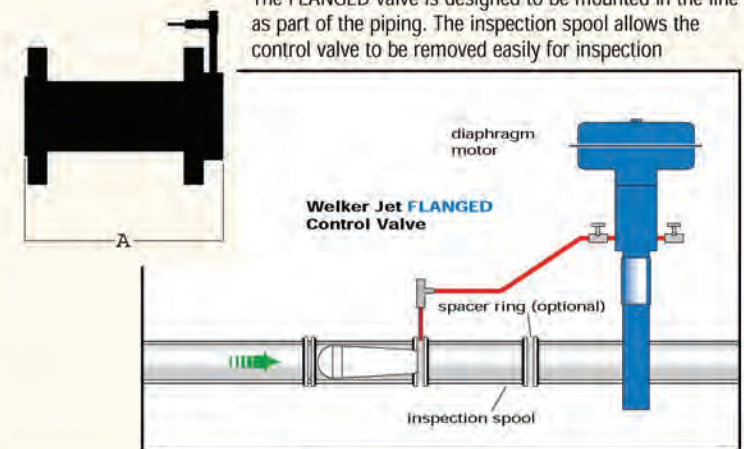

## Dimension Chart

SIZE	N STYLE		NF STYLE "A" DIM			TE STYLE "A" DIM			
	A DIM	B DIM	150 ANSI	300 ANSI	600 ANSI	150 ANSI	300 ANSI	600 ANSI	
1"	IN	4.56	1	7.25	7.75	8.25	7.25	7.75	8.25
	MM	115.8	25.4	184.2	196.9	209.6	184.2	196.9	209.6
2" x 1"	IN			10.5	10.5	11.25	10.5	10.5	11.25
	MM			266.7	266.7	285.8	266.7	266.7	285.8
2"	IN	7.31	1.125	10	10.5	11.25	10	10.5	11.25
	MM	185.7	28.6	254	266.7	285.8	254	266.7	285.8
4"	IN	10.75	1.125	13.875	14.5	15.5	13.875	14.5	15.5
	MM	273.1	28.6	352.4	368.3	393.7	352.4	368.3	393.7
6"	IN	18.625	2.25	17.75	18.625	20	25	25	25
	MM	473.1	57.2	450.9	473.1	508	635	635	635
8"	IN			21.38	23.38	24	32	32	32
	MM			543.1	593.9	609.6	812.8	812.8	812.8
8" x 10"	IN	24.5	2.5						
	MM	622.3	63.5						
8" x 12"	IN	24.5	2.5						
	MM	622.3	63.5						

# SPECIFICATIONS

## WELKER JET® Capacity Equation

For Gas:  $Q \text{ scfh} = \sqrt{\frac{520}{GT}} C_g P_1 \text{ Sin} \left[ \frac{3417}{C_1} \sqrt{\frac{\Delta P}{P_1}} \right] \text{ DEG}$

For Liquid:  $V = \frac{C_v \sqrt{\Delta P}}{\sqrt{G_f}}$

At critical conditions,  $\text{Sin} \left[ \frac{3417}{C_1} \sqrt{\frac{\Delta P}{P_1}} \right] \text{ DEG}$  becomes one. In the **WELKER JET®** Control Valve, critical flow occurs when  $P_2$  is approximately 80% of  $P_1$ .

SIZE	$C_g$	$C_v$	$C_1$
		N, NF & TE	N, NF & TE
1"	699	38	18.3
2"	2,044	107	19.1
4"	5,708	318	17.94
6"	13,170	658	20.0
8" x 10"	15,633	868	18.0
8" x 12"	23,744	1,319	18.0

- $Q$  = Gas flow in standard cubic feet per hour
- $G$  = Gas specific gravity
- $T$  = Flowing temperature degree Rankin ( $460 + T_f$ )
- $P_1$  = Inlet pressure (PSIA)
- $\Delta P$  = Pressure differential (PSI)
- $C_1 = C_g / C_v$
- $V$  = Liquid Flow in U.S. gallons per minute
- $G_f$  = Liquid Specific Gravity

**WELKER JET® Control Valves** can be matched to a relief valve by using capacity restricting rear plates.

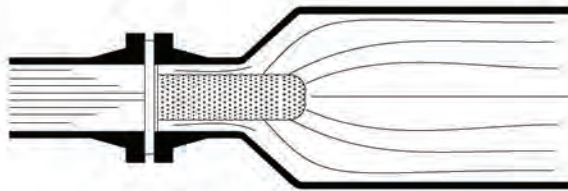

Flow with Welker In-Line Diffuser

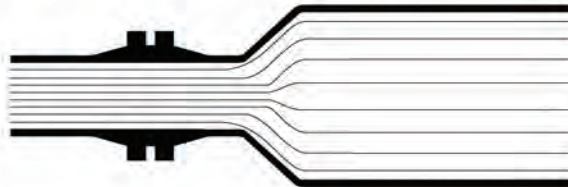

Ideal Flow

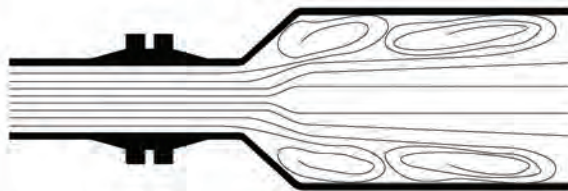

Actual Flow

## WELKER® IN-LINE DIFFUSER

### Reduces Aerodynamic Noise and Vibration

Welker in-line diffusers are designed to produce a constant velocity profile which reduces turbulence, thereby reducing noise and vibration. The gas exiting a control valve at high velocity into some piping configurations is a major source of noise and vibration. Vortices form in the larger sections of the piping or headers adjacent to the main flow path. The formation of these vortices is detrimental for three reasons:

1. A vortex requires energy which will be obtained at the expense of the main flow path to keep it in motion.
2. A vortex has a negative velocity aspect in that the gas molecules in the vortex spin around and collide with the incoming gas molecules head-on.
3. A vortex is not stable and in fact pulsates, inducing noise and vibration into the pipe itself. The pulsation and vibration created by these intense vortices can have a detrimental effect on operations and a drastic effect on measurement.

## Welker

13839 West Bellfort, Sugar Land, Texas 77498-1671  
 Telephone: (281) 491-2331 Toll Free: (800) 776-7267  
 Fax: (281) 491-8344  
 Email: Sales@welkereng.com  
 Web Site: www.welkereng.com

